

Toronto City
Costumes sur mesure



STYLE & OPTIONS

Finitions Pantalon

■ **SHOWROOM NANTES**

10 rue du bois briand
44300 Nantes
Tél. 02 40 31 93 44

www.votre-costume-sur-mesure.fr

Finitions Pantalon

POCHES

POCHES AVANT



Italienne

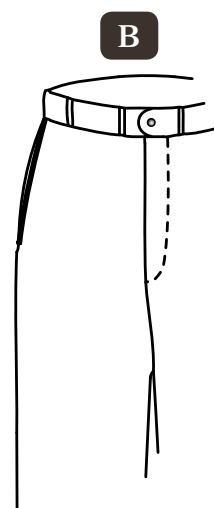

Couture

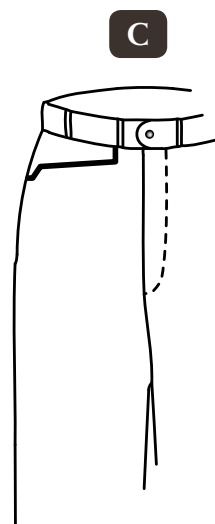

Cavalière

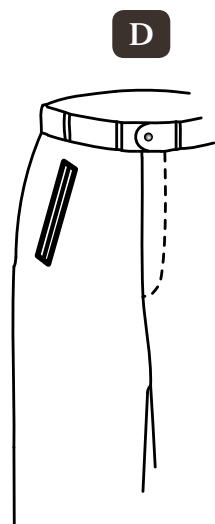

Passepoilée

POCHES ARRIÈRE

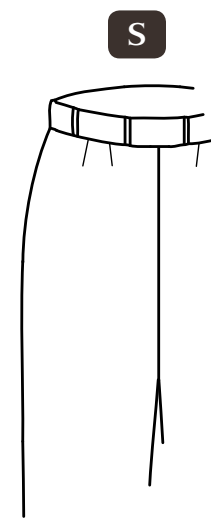

Sans poche

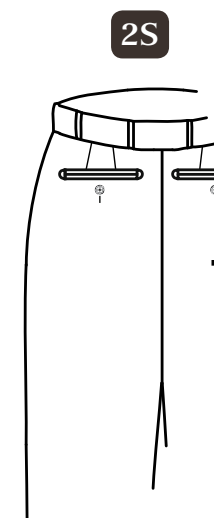

2 poches

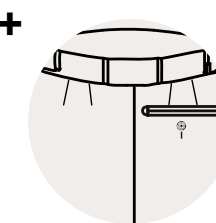

1S

1 poche

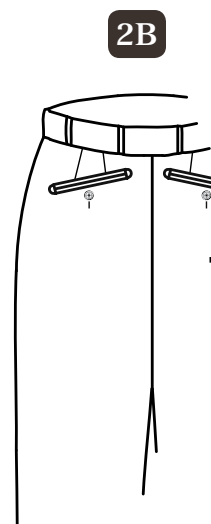

2 poches en biais

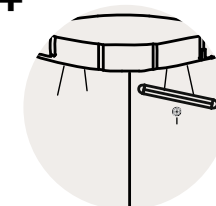

1B

1 poche en biais

Finitions Pantalon

BASIC

Ces options ne sont pas compatibles avec la poche cavalière

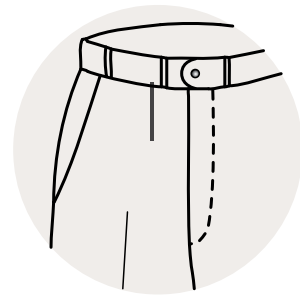

P1
Devant avec une pince



P1A
1 pli vers l'arrière



P1B
1 pli vers l'avant

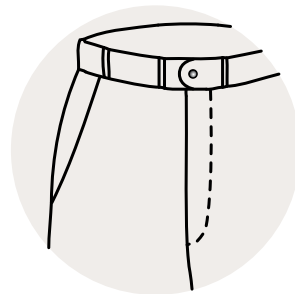

PSF
Finition sans pli de repassage



P0
Devant sans pince

Finitions Pantalon

CEINTURE



CB

Ceinture sans passants



CD

Ceinture avec passants doubles



CL

Ceinture avec passants larges



CRE

Ceinture avec réglage élastique et boutons



CRM

Ceinture avec réglage mécanique

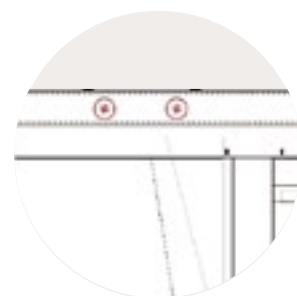

PBR

Boutons bretelles

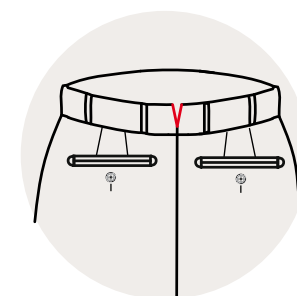

PDS

Encoche à la ceinture "after dinner Split"

Code à inscrire dans la case "options secondaires".

■ SHOWROOM NANTES

10 rue du bois briand
44300 Nantes
Tél. 02 40 31 93 44

Finitions Pantalon

FINITION BAS

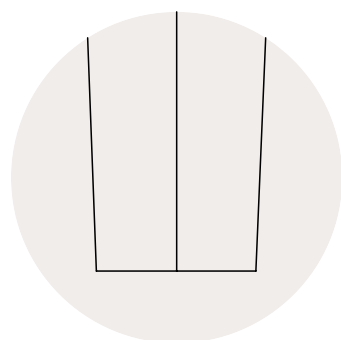

PF:
Bas fini

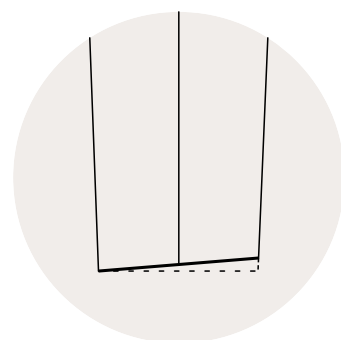

PFC:
Bas fini, plus court devant 1 cm

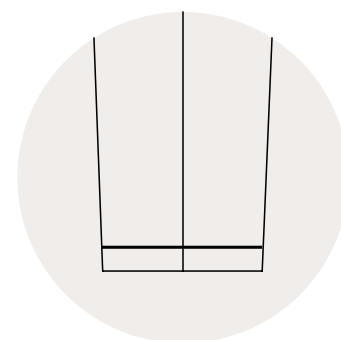

PF3:
Bas fini / revers de 3 cm

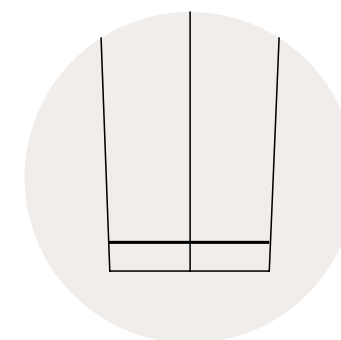

PF4:
Bas fini / revers de 4 cm

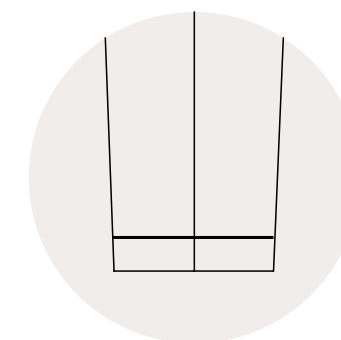

PF5:
Bas fini / revers de 5 cm

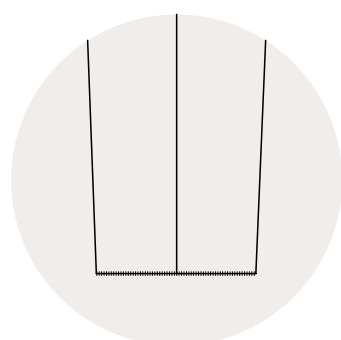

PFO:
Bas ouvert

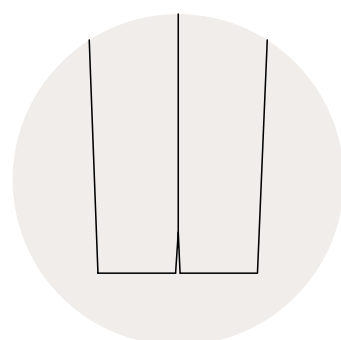

PFV:
Bas fini avec fente

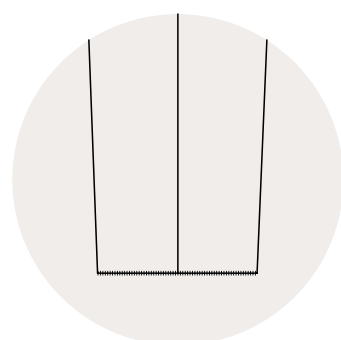

PO3:
Bas ouvert / revers de 3 cm

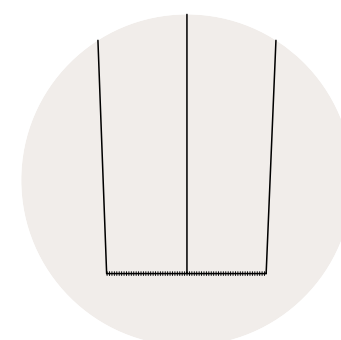

PO4:
Bas ouvert / revers de 4 cm

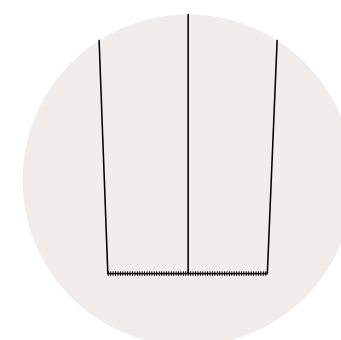

PO5:
Bas ouvert / revers de 5 cm

Finitions Pantalon

SARTORIAL

PA11

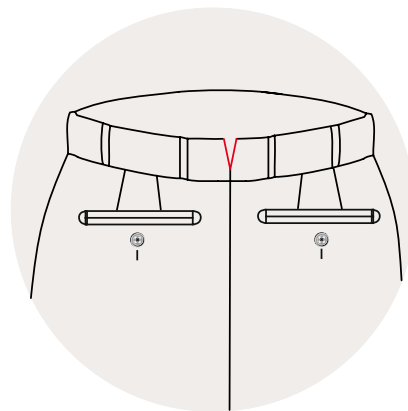

V anatomique
"After dinner Split"

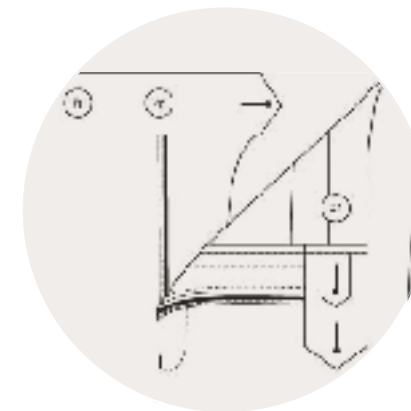

Fermeture double patte /
2 boutons



AMF poches et braguette
pantalon

Le code PA11 sera automatiquement sélectionné avec l'option "TRADITIONNELLE".

■ SHOWROOM NANTES

10 rue du bois briand
44300 Nantes
Tél. 02 40 31 93 44

www.votre-costume-sur-mesure.fr

Finitions Pantalon

DETAILS



PM:
Poche montre sans rabat

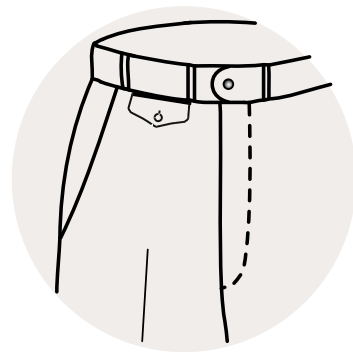

PMR:
Poche montre avec rabat

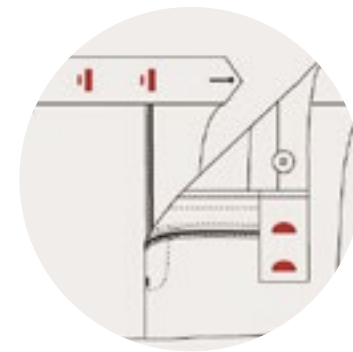

PCA:
Fermeture 2 agrafes

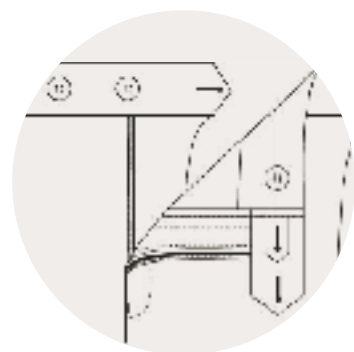

PCB:
Fermeture double patte / 2 boutons

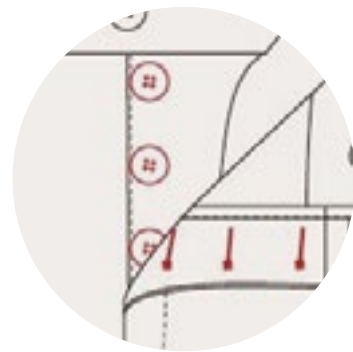

PBB:
Braguette à boutons

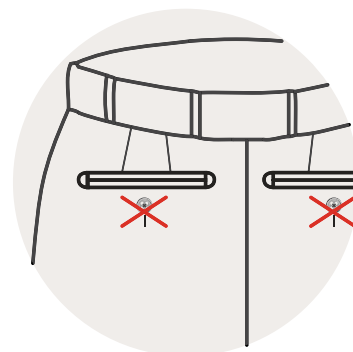

POD:
Sans boutonnière poche dos

Code à inscrire dans la case "OPTIONS" du bon de commande.

■ SHOWROOM NANTES

10 rue du bois briand
44300 Nantes
Tél. 02 40 31 93 44